

CBA V User Manual

JULY 2021

Introduction

Thank you for choosing the West Mountain Radio Computerized Battery Analyzer (CBA). The CBA is a powerful test instrument that measures, graphs, and compares performance of both primary and secondary (rechargeable) batteries and individual cells. The CBA allows for the precise measurement of battery capacity and takes the guesswork out of choosing the best battery for your application.

The CBA is much more than a simple battery voltage tester or a battery load tester. It will test virtually any type or size of battery, any chemistry or number of cells, up to 55 volts. Now anyone can do scientific battery tests for a reasonable price.

The CBA alone is capable of tests up to a maximum of either 40 amps or 150 watts for short periods of time. For continuous operation, suggested values are 20 amps or 100 watts, whichever is higher. When used with an optional amplifier, tests can be done at 500 watts.

The CBA not only tests the total amount of energy stored in a battery (capacity in amp-hours), but also graphically displays and charts the voltage versus time using a constant current load. Graphs may be displayed, saved and printed, and the axis parameters can be changed at anytime. Multiple test graphs of the same battery, or multiple batteries, may be compared or overlaid; a very useful feature. Battery test data may be printed in color or black and white to paper or convenient test labels to put directly on the tested batteries. An optional external temperature probe provides automatic over temperature test cutoff.

The CBA is ruggedly built and supplied with 12 gauge wire and Powerpole[®] connectors for battery test connections. It is small with a high performance cooling system and quiet fan. LED indicators are visible from across a room that display communication and test status.

Standard software supplied with the CBA is easy to use, intuitive, and designed to protect both the CBA and batteries being tested. It provides automatic sensing of battery cell count, a safety check of the test rate, and recommends a minimum safe discharge voltage. There are user editable and recallable battery test profiles and Capacity Discharge tests may be viewed in Amp Hours, Watt Hours or Minutes. The Charge Monitor Test mode charts and records voltage rise during a charge or discharge. Lab calibration current adjustment is a standard user feature to improve accuracy for testing at very low discharge rates, or for critical applications.

The optional Extended Software license provides all the features of the standard version, but adds five additional test modes: Time Discharge, Duty Cycle, Constant Power, Multiple Discharge and Constant Resistance. Results can be graphed as Voltage vs. Amp hours, Watt hours, Minutes or Ragone depending on the type of test. Ragone graphs require the weight of the battery/batteries to be accurate.

A CBA IV enables another test: Power Profile. This test is very useful for power supply testing or solar cell analysis. The resulting graph displays Voltage vs. Amps or Watts. The Extended Software version also adds the ability to graph battery temperature with CBA III and CBA IV (when the optional temperature probe is connected). An additional lab calibration feature makes it possible to compensate for test lead resistance, giving accurate readings at the battery terminals.

When using a CBA III with a 500W Amplifier, Extended Software is required.

When using a CBA IV with a 500W Amplifier, Standard or Extended Software will provide provisions for operation with amplifiers for testing at high discharge rates or doing destructive testing.

CBA HR

Specifically designed to test and evaluate small cells and batteries – those capable of supplying quite low discharge currents. Such small cells must be evaluated using even greater measurement precision than what is capable with CBA IV model. Designed to precisely test virtually any small size battery, any chemistry or number of cells, from 0.7 to 10 volts. The CBA HR is capable of testing batteries at load currents from 1 mA to 1000 mA, (10 watt maximum), in increments of 1 mA.

An optional 4-wire test harness improves voltage measurement accuracy by minimizing the voltage sensing lead wire resistance effect. Some optional harnesses also include an external magnetic probe, which when used with optional Extended Software allow logging of battery / ambient temperature and automatic over-temperature test cutoff.

Standard Software is supplied with the CBA HR. In addition to the four basic test modes included with the CBA IV (Mission Profile, Discharge, Charge Monitor, and Power Profile), the CBA HR adds two additional test modes (Duty Cycle and Multiple Discharge) to allow user simulation of real world battery load variations found in typical remote sensor sleep / transmit applications.

The optional Extended Software license provides the ability to graph battery temperature when the optional magnetic temperature probe is connected. This optional temperature probe is included in selected test harness assemblies and is connected to the CBA HR via a 3.5mm accessory input.

The CBA HR is not designed to be used with optional West Mountain Radio 500 watt CBA Amplifiers. For higher test currents and voltages that exceed the CBA HR's ratings - use the West Mountain Radior CBA IV, which can accommodate one or more 500W Amplifiers.

CBA IV Specifications

Electrical

- Maximum continuous discharge rate: 100 watts
- Maximum limited term discharge rate with < 3500 ma-hour battery: 125 watts
- Maximum limited term discharge rate with < 1000 ma-hour battery: 150 watts
- 0-3 amp accuracy: typically better than + - 10 mA
- 3-40 amp accuracy: typically better than + - 45 mA
- 0-5 volt accuracy: typically better than + - .005 volts
- 5-15 volt accuracy: typically better than + - .01 volts
- 10-60 volt accuracy: typically better than + - .05 volts
- Maximum operating voltage: 55 Volts (48 Volt Lead Acid Telecom supported)
- Maximum discharge rate: 40 Amps (Battery dependent, 100 watt continuous)
- Minimum discharge voltage to maintain 30 Amps 0.9 Volts (Battery dependent)
- Minimum Voltage for a 40 Amp discharge: 2 Volts at completion of test (Battery dependent)
- Minimum discharge rate: 0.01 Amps (10 mA)
- Residual current drain, battery connected while not in use: < 3 mA @ 12 volts

Hardware / Software

- High performance micro controller with USB interface and 12 bit A/D conversion
- USB powered: CBA does not use battery being tested to run the CBA or fan
- Computer Interface: USB Type A to B (Cable Included)
- Load Connections (Battery Test): Powerpole (+) / (-)
- I/O Port: 5 pin flat header for Temp Input & Serial Port
- LED indicators: System ready and Test in progress, viewable from across a room
- Internal over temperature sensing and protection
- Internal user replaceable fuse: ATO / ATC 25 Amp ; ships with spare 40 Amp
- Graph printing on any standard color or B&W printer
- Battery test label printing on standard 5160 / 8160 stick-on labels
- Dimensions: 3.5" H x 2.8" W x 3.6" D
- Weight: 16 oz.

CBA HR (High Resolution) Specifications

Electrical

- Maximum continuous discharge rate: 10 watts
- Maximum discharge current: 1000 mA (1.0 Amp)
- Minimum discharge current: 1.0 mA (0.001 Amp)
- Discharge Current Accuracy: better than +/- 20 uA @ 1 mA discharge
- Maximum operating test voltage: 10 volts
- Minimum operating test voltage: 0.7 volts
- Voltage reading accuracy: better than +/- 0.01 volts
- Residual current drain, battery connected while not in use: < 200 uA @ 9 volts

Hardware / Software

- High performance micro controller with USB interface and 12 bit A/D conversion
- USB powered: CBA does not use battery being tested to run the CBA or fan
- Computer Interface: USB Type A to B (Cable Included)
- Load Connections (Battery Test): Powerpole (+) / (-)
- I/O Port: 3.5 mm for Temp Input & Remote Voltage sensing (4-wire) – when using temperature input, remote voltage sensing harness must also be used
- LED indicators: System ready and Test in progress, viewable from across a room
- Internal over temperature sensing and protection
- Internal user replaceable fuse: ATO / ATC 2 Amp
- Graph printing on any standard color or B&W printer
- Battery test label printing on standard 5160 / 8160 stick-on labels
- Dimensions: 1.5" H x 2.8" W x 3.6" D
- Weight: 4 oz.

Safety Precautions

The West Mountain Radio CBA family of battery testers are inherently safe, but the batteries being tested are not. Any system that stores energy is potentially dangerous. Some types of batteries are safer than others, but all are capable of causing explosions or fires.

For technical information on a specific battery, refer to the Battery Manufacturers website. Most battery labels have limited information, but the manufacturer's website usually includes more detailed technical information. General information for batteries is also available on the West Mountain Radio CD. Select Battery Information and FAQs.

Primary Safety Considerations:

- Never discharge a battery at a higher discharge rate than it was designed for.
- Never use a battery that has poorly insulated, frayed wiring, or exposed metal parts.
- Never connect a battery with reverse polarity.
- Never test a battery near flammable materials.
- Never allow a battery to reach a temperature that is too hot to touch.
- Recharge batteries immediately with an appropriate battery charger after the test is completed. Some types do not like to remain discharged for extended periods of time.
- Never test or charge batteries while unattended.
- Always have a fire extinguisher nearby.

CBA Operating Requirements:

- Never connect a battery with the polarity reversed.
- Always connect the USB cable to the CBA BEFORE connecting the battery.
- Be aware the heatsink of the CBA is at battery potential (positive terminal of battery).
- Never connect a battery to the CBA if that battery is connected to something else.
- Contact West Mountain Radio for support before connecting to a USB hub.
- Operate the CBA in a cool dry location.
- Never allow metal parts or wiring of the battery to come in contact with the metal heat sink of the CBA.
- Never allow the cooling fan to be blocked or jammed.
- Do not ignore the warnings from the CBA Software.
- The CBA can get hot. Do not touch the metal heat sink while, or shortly after, conducting a high power test.

Lead Acid Battery Safety Warnings:

Adhere to all safety considerations with lead acid batteries, especially while charging. These batteries, especially automotive and marine types, give off explosive hydrogen gas when charged. A nearby or internal spark or flame can cause a lead acid battery to explode sending liquid acid and lead shrapnel in all directions. This is particularly dangerous and frequently causes blindness or severe scarring injuries.

Never use a standard lead acid battery without proper ventilation. Sealed lead acid batteries such as gelled or AGM (absorbed glass mat) types are much safer. Automotive and marine types are not as safe and should be used in protective ventilated housings.

Never make the last connection to a lead acid battery that may cause a spark on the terminal. Always connect the load or charger last, and at a safe distance away from the battery.

NiCad, NiMh, and Alkaline Safety Warnings:

Adhere to all safety considerations, as these types of batteries can also be dangerous. If they are shorted out or charged/discharged at too high a rate, they can overheat and explode. A single D size NiCad cell can actually melt a 10 penny (9 gauge) nail (it is not recommended to attempt.)

Lithium Safety Warnings:

Reprinted with permission of the Academy of Model Aeronautics

Words in bold ***and*** () were added by West Mountain Radio

Lithium Battery Fires

Lithium batteries are becoming very popular for powering the control and power systems in our models. This is true because of their very high energy density (amp-hrs/wt. ratio) compared to NiCads or other batteries. With high energy comes increased risk in their use. The, principal, risk is FIRE which can result from improper charging, crash damage, or shorting the batteries. All vendors of these batteries warn their customers of this danger and recommend extreme caution in their use. In spite of this many fires have occurred as a result of the use of Lithium Polymer batteries, resulting in loss of models, automobiles, and other property. Homes and garages and workshops have also burned. A lithium battery fire is very hot (several thousand degrees) and is an excellent initiator for ancillary (resulting) fires. Fire occurs due to contact between Lithium and oxygen in the air. It does not need any other source of ignition, or fuel to start, and burns almost explosively.

These batteries must be used in a manner that precludes ancillary fire. The following is recommended:

1. Store, and charge (discharge), in a fireproof container; never in your model.
2. Charge (discharge), in a protected area devoid of combustibles. Always stand watch over the charging (discharging), process. Never leave the charging process unattended.
3. In the event of damage from crashes, etc, carefully remove to a safe place for at least a half hour to observe. Physically damaged cells could erupt into flame, and, after sufficient time to ensure safety, should be discarded in accordance with the instructions which came with the batteries. Never attempt to charge (discharge) a cell with physical damage, regardless of how slight.
4. Always use chargers designed for the specific purpose, preferably having a fixed setting for your particular pack. Many fires occur in using selectable/adjustable chargers

improperly set. Never attempt to charge Lithium cells with a charger which is not specifically designed for charging Lithium cells. Never use chargers designed for Nickel Cadmium batteries.

5. Use charging systems that monitor and control the charge state of each cell in the pack. Unbalanced cells can lead to disaster if it permits overcharge of a single cell in the pack. If the batteries show any sign of swelling, discontinue charging, and remove them to a safe place outside as they could erupt into flames.
6. Most important: NEVER PLUG IN A BATTERY AND LEAVE IT TO CHARGE (DISCHARGE), UNATTENDED OVERNIGHT. Serious fires have resulted from this practice.
7. Do not attempt to make your own battery packs from individual cells. These batteries CANNOT be handled and charged casually such as has been the practice for years with other types of batteries. The consequence of this practice can be very serious resulting in major property damage and/ or personal harm.

Primary Safety Considerations:

- Never discharge a battery at a higher discharge rate than it is designed for.
- Never use a battery that has poorly insulated or frayed wiring or exposed metal parts.
- Never connect a battery with reverse polarity.
- Be aware the heatsink of the CBA is at battery potential (positive terminal of battery).
- Never test a battery near flammable materials.
- Never allow a battery reach a temperature that causes it to get so hot that it may be too hot to touch.
- Recharge batteries immediately with an appropriate battery charger after tests are completed. Some types do not like to remain discharged for extended periods of time.
- Never test or charge batteries while unattended.
- Always have a fire extinguisher nearby.

Liability Disclaimer

West Mountain Radio will not be liable to you (whether under the law of contract, the law of torts or otherwise) in relation to the contents of, or use of, or otherwise in connection with, the CBA ("product"):

- To the extent that the product may cause any bodily or equipment damage;
- For any indirect, special or consequential loss of any kind;
- For any business losses, loss of revenue, income, profits or anticipated savings, loss of contracts or business relationships, loss of reputation or goodwill, or loss or corruption of information or data.

By using this product, you agree to the limitations of liability set forth in this disclaimer are reasonable.

Getting Started

It is recommended to read this entire manual and help files for a full understanding of the CBA and software operation.

1. From the CD ROM opening screen, click on “Software and Hardware Installation”. Follow the instructions on the screen to complete both the hardware and software installations.
2. Connect the CBA to the PC's USB port using the supplied cable before connecting a battery.

NOTE: If the Windows message “Found new Hardware” appears, the previous step was not completed.

3. Start the West Mountain Radio CBA program.

NOTE: For a CBA III the green LED will come on when the program starts. For CBA IVHR the LED will light as soon as the drivers are found. The software should start with a “New Test” screen in the “Auto-Check” profile.

4. Connect the battery with very short, solid, low resistance connections using the proper connectors and polarity.

WARNING: Be certain that you have the polarity correct. For Standard convention: RED to RED, BLACK to BLACK, and PLUS to PLUS, MINUS to MINUS.

4. On the TEST ribbon click on NEW TEST.



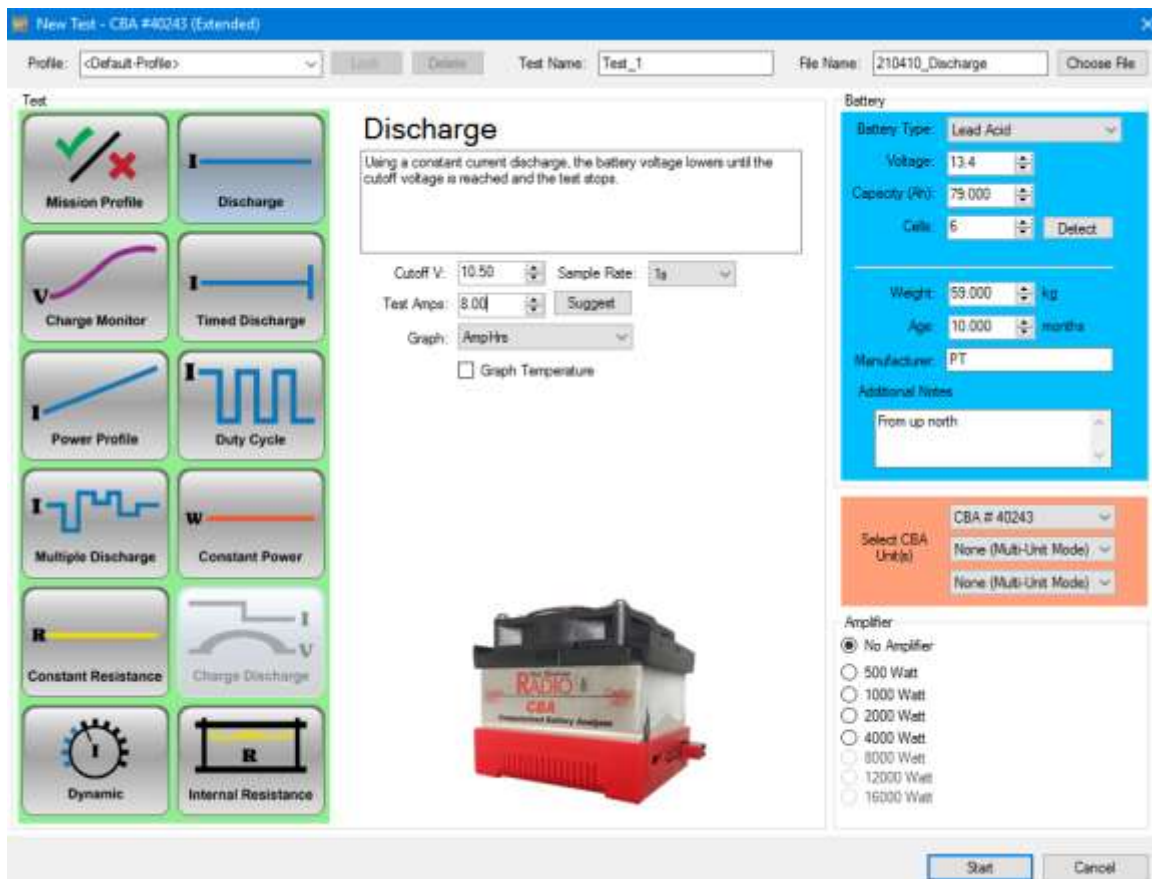

5. Click on the discharge icon on the left side and make sure the battery information on the right side is correct.
6. Set the cut-off voltage for when for when to stop the test. A 12V Lead-Acid battery is usually rated for voltages down to 10.5 volts.

WARNING: Do not choose a higher discharge rate than the battery is capable of. See the the battery manufacturer's specifications.

NOTE: If the no load battery "Voltage" multiplied times the "Test Amps" selected (Volts x Amps = Watts) exceeds the wattage rating of the CBA, or the default recommended maximum discharge rate for a given battery type, the software will prompt to lower the discharge current before starting a test. The CBA will run tests at up to 150 watts, for short periods of time, with a battery that has a rated capacity of 1 Amp-Hr or less, up to 125 watts below 3.5 Amp-Hrs and 100 watts for any capacity battery. The CBA HR will run tests up to 10 watts, with maximum voltage of 10 volts and maximum current of 1 Amp.

7. Set the current draw for the test. This will depend on the battery type. For a car battery, select around 8 amps.

8. Click START to begin the test.

Chart Features

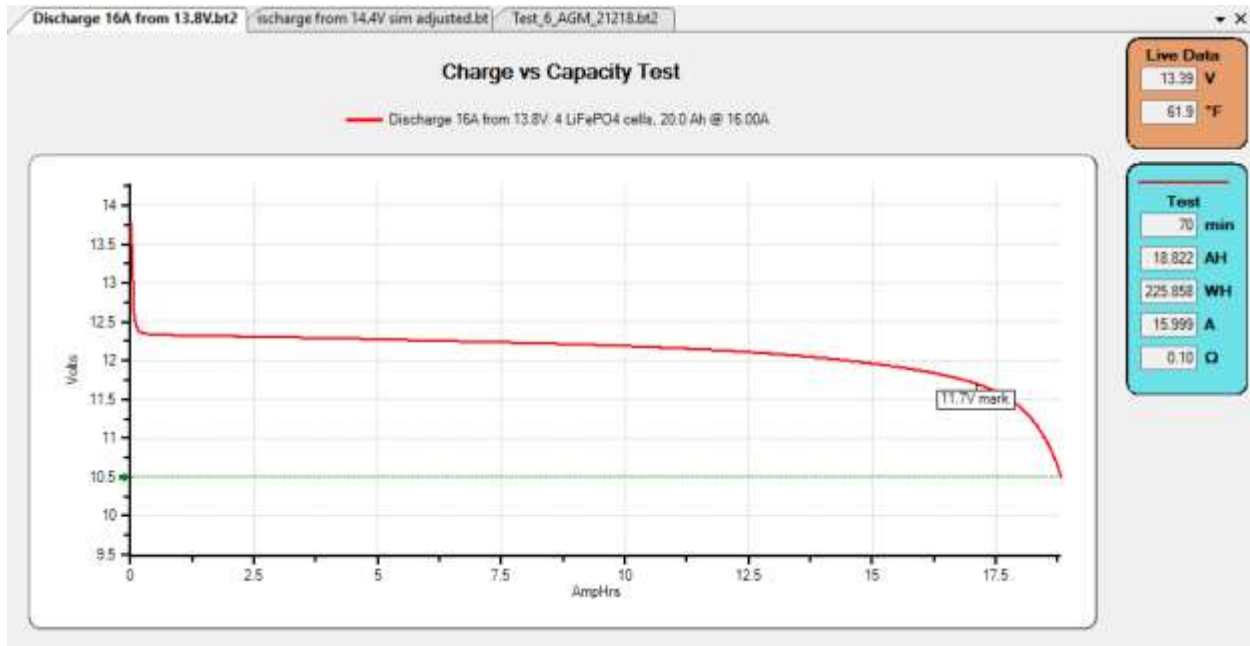

This screen shot shows three charts (files). Each can be selected by clicking on the tabs at the top. The chart ribbon can be used to show all charts at the same time if desired.

The chart title at the top can be edited under chart properties.

The legend under the title can be turned on or off and can be edited as well under Test Properties.

The red line is the test results and the green line if the cutoff voltage entered for this test.

The box with 11.7V in it was a note added by the user to the test. Notes can be added at any time and under the chart ribbon they can be turned on or off.

Many of these features can be quickly accessed by right-clicking on the chart.

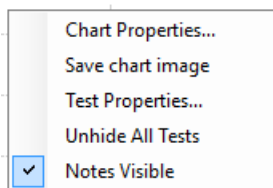

When the cursor is moved to a point on the test line, details from that point pop-up like the following:

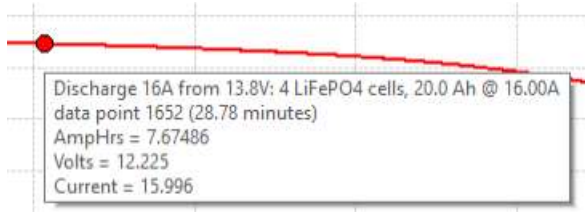

Quickly convert that data to a note by right-clicking and selecting annotate.

A number of other short-cuts are also available when right-clicking on a line.

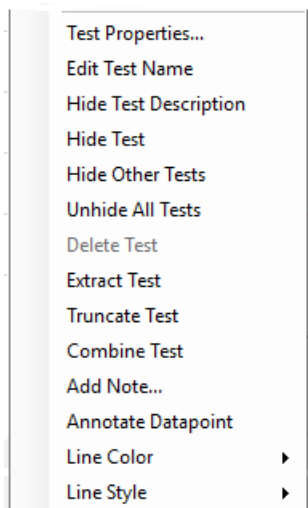

The data on the right side are split into three groups by color:

Brown: Displays live battery data. This updates whether a test is running on it and includes the Battery voltage and temperature if an external probe is connected.

Blue: Test data for a completed test. Notice the line color at the top.

To see data for another test, click on that line.

Green: Test data for a test that is running.

Program Features

The installation and basic operation is covered in the Getting Started section of this manual and Help file. This section gives a detailed explanation of using the program and its features.

The software uses a ribbon menu system where the primary ribbons are as follows:

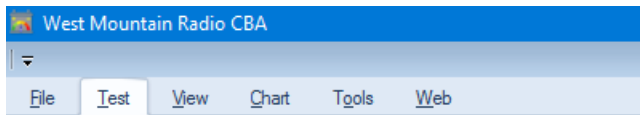

Click on the small down arrow above the menu to hide the ribbon and make more space on the screen. Click on the ribbon title to access the functions under that ribbon. It is also possible to double click on a ribbon tab and it will minimize the ribbon and vice versa.

The lower right status bar shows the currently selected CBA and the status. There will be a green check mark if the USB cable is plugged in. The fan is moving if the CBA is running a test.



File Menu



Open:

Allows for opening any saved file. Old test files from previous version 1 of CBA software may be opened by changing "Files of type" from .bt2 to .bt1. When open and displaying an old style .bt1 file, it will be converted to the new .bt2 and saved in the new format.

Recent Files:

Re-opens a file that was recently open.



Closes the file for the currently selected tab on the screen.



Closes all files shown on the screen.



Saves the file for the currently selected tab on the screen.



Saves the file for the currently selected tab under a new name. The old file will still exist.



Closes the file for the currently selected tab on the screen and then deletes the file from the disk.



Rename the file for the currently selected tab on the screen on the disk.



Asks for a file open, but then merges the data with the currently selected tab. If the tab has one test trace on the screen and the selected file also has a single test trace, then the screen will

now show both tests on top of one another. The data is not saved, and it necessary to save the new merge by doing a Save. Only tests of the same type can be overlaid.



Print

Prints an image of the currently selected tab to a printer.



Export as CSV

Creates a text file with comma delimited data for the currently selected file. In a spreadsheet program the data would look like this:

21	Test	Time (s)	Voltage (V)	Current
22	Discharge 16A from 14.4V	0	13.955	15.965
23	Discharge 16A from 14.4V	2	13.916	15.965
24	Discharge 16A from 14.4V	3	13.785	15.965
25	Discharge 16A from 14.4V	4	13.706	15.965
26	Discharge 16A from 14.4V	5	13.622	15.965
27	Discharge 16A from 14.4V	6	13.535	15.965
28	Discharge 16A from 14.4V	8	13.446	15.965
29	Discharge 16A from 14.4V	9	13.354	15.965
30	Discharge 16A from 14.4V	11	13.166	15.965
31	Discharge 16A from 14.4V	12	12.972	15.965
32	Discharge 16A from 14.4V	13	12.874	15.965
33	Discharge 16A from 14.4V	15	12.774	15.965
34	Discharge 16A from 14.4V	16	12.689	15.965
35	Discharge 16A from 14.4V	17	12.624	15.965

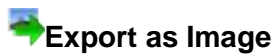

Export as Image

Creates a bitmap (.bmp) image file for the currently selected chart.



Export Summary

Creates a text file, comma delimited with a summary of all the tests on the current file. In a spreadsheet, the data would look like the following:

1	Test Name	Total Test Time	Amphours	Test Current
2	Discharge 16A from 14.4V	1:10:56	18.915	16.000 Amps
3	Discharge 16A from 14.1V	1:10:44	18.857	16.000 Amps
4	Discharge 16A from 13.8V	1:10:36	18.822	16.000 Amps

Test Menu



New Test

This is the function that starts a new test. For details, see the section "Test Configuration" of this manual.

Append Test

Append test adds a test to the current file, which may have multiple test traces.

Quick Load Test

This function starts a dynamic load test where the user can control the load current on the right side of the screen. This is a fast way to cause the CBA to just start drawing current.

Test Properties

This will show the screen that was up for stating the test. Some information can be changed such as the battery manufacturer. Other information is just shown for reference.

Start Test

Stop Test

Pause Test

These functions control the execution of the test.

Print Labels

From the main dialog box, select the tests to print labels for. Under **Label Settings** can specify the type of label and what is include to print on the label.

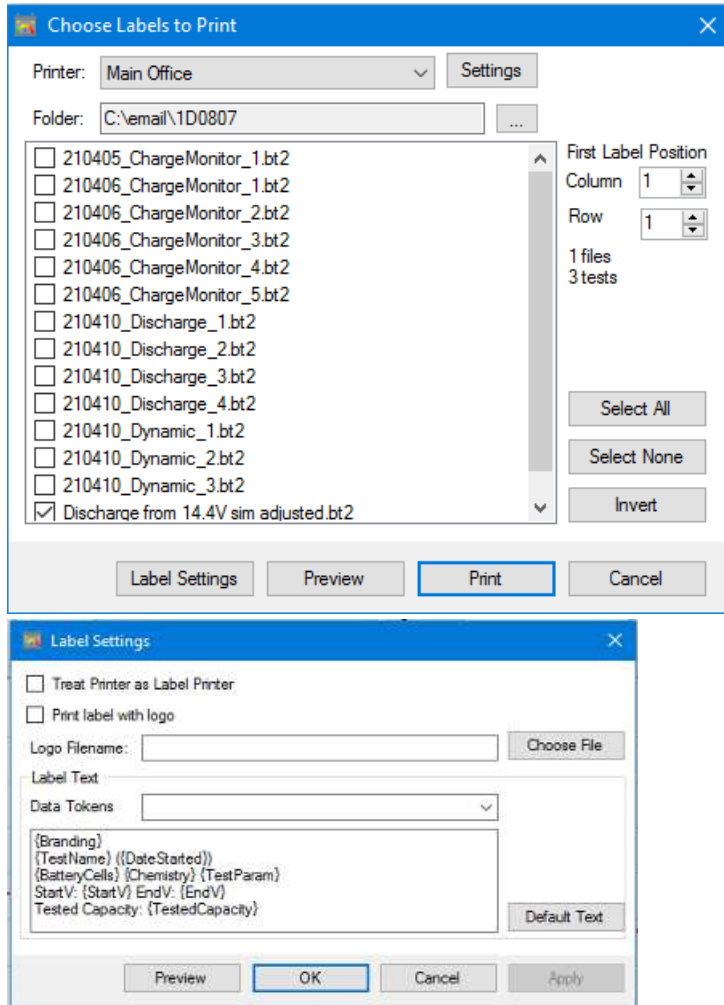

It is also possible to include a company logo or any image on each label. If the filename is empty and the "Print label with logo" option is selected, the software will print a label with a demo logo to give the user an idea of how including a logo would look.

➔ Export Test

This function creates a .CSV file for just one test on the chart.

View Menu

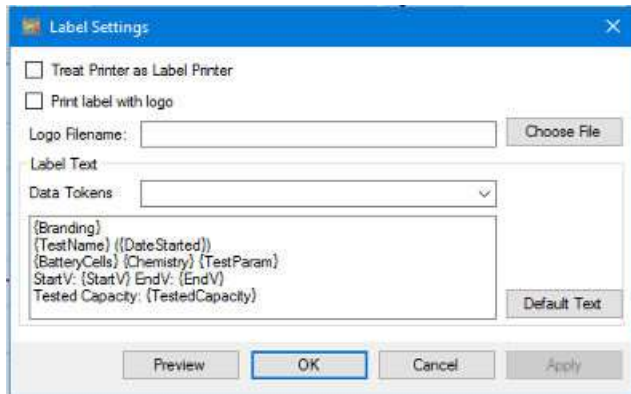
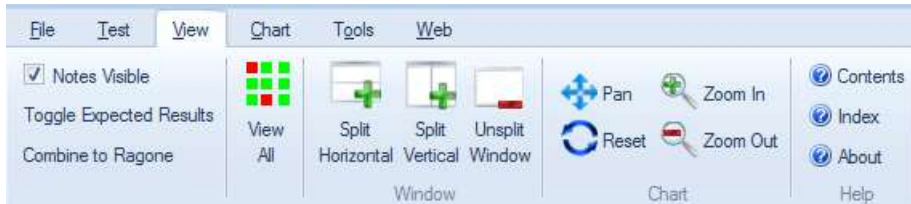

Notes Visible

Check to see the notes on the chart.

Expected Results

Check to see a model of the battery expected results. When the battery trace falls towards the lower bounds of this shadow at the end of a discharge, then the battery is considered end of life. This is a new feature and may require some tweaking as we are provided user feedback.

Combine to Ragone

Produce a Ragone chart showing the battery range, begin by running a number of tests on the same battery with different loads. Then overlay each test on the same chart. Finally, click this icon and the chart will be converted.

 **View All**

Opens a window that shows the current status of all running tests.

 **Split Horizontal / Vertical**

Show multiple charts vertically or horizontally.

 **Unsplit Window**

pressing shift while holding the mouse down performs the other mode action. So If in zoom mode, shift will cause it to pan and vice versa.

 **Pan/Zoom**

When the icon reads **Pan** it is in **zoom** mode. Hold the mouse button down and draw a box around an area of the screen, it will zoom into that area. When the icon reads **Zoom**, hold the mouse button down and move the mouse to pan the screen. Pressing shift while holding the mouse down performs the other mode action. So If in zoom mode, shift will cause it to pan and vice versa.

 **Zoom +/-**

Executes a simple zoom in and out.

 **Reset**

Resets the **Zoom/Pan** to full screen.

Chart Menu

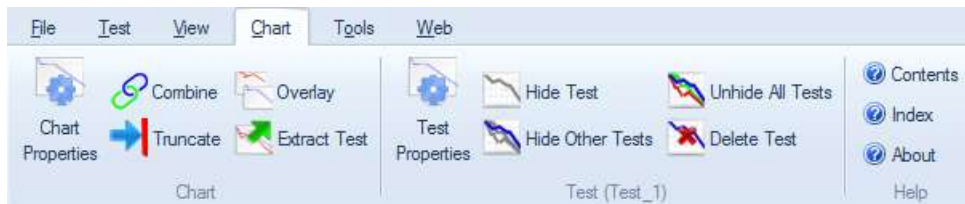

Chart Properties

Chart Properties

Title: April 2021 R302 Cells

Show

Legend

Gridlines

Cutoff Voltage Line

X-Axis Scrollbar

Y-Axis Scrollbar

X-Axis Range: 0.000 to 0.008

Y-Axis Range: 3.000 to 5.956

Graph Type: AmpHrs

View Voltage Notes

OK Cancel

These settings affect the way the chart appears. These settings are saved in the test file.

Combine

Appends one test to the end of the currently selected test.

Truncate

Click on a point on the test and this button will eliminate all data points after the point selected. In order to change the file, it must be **saved**.

Extract Test

Click on one of the lines on the chart. This will create a new file with just that test in it. Use this function to reverse an overlay.

Test Properties

This will show the screen that was up for stating the test. Some information can be changed such as the battery manufacturer. Other information is just shown for reference.

 **Hide Test / Hide Other Tests**

 **Unhide Tests**

These functions are used to remove clutter from a chart. Click on a test line and then hide that line or hide all the other lines.

 **Delete Test**

Click on a test line and this button will remove that test from the chart. In order to change the file, it must be **saved**.

Tools Menu



Preferences

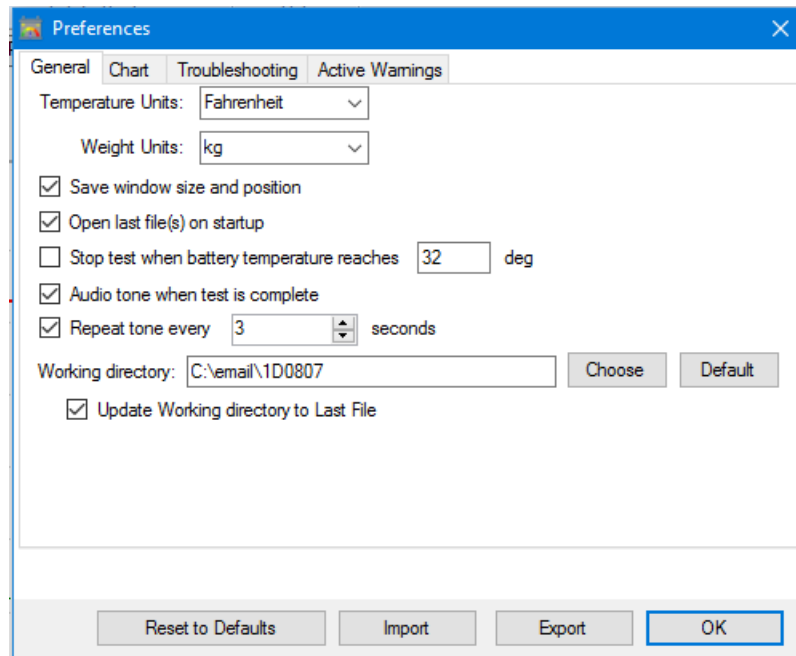

These settings are global to the program as opposed to a chart file. Customize certain settings for the program, such as:

Temperature Units to allow for selecting degrees in C or F. This applies to all tests. If an external temperature probe is connected, place it on the battery and the any test or current draw would stop if the battery gets to this temperature.

Save window size and position causes the program to come back with the same window the next time it is opened.

Stop test when battery temperature reaches this applies to all tests. If an external temperature probe is connected, place it on the battery and the any test or current draw would stop if the battery gets to this temperature.

Print charts in black and white is for setting it to code the graphs for identity when not color coded.

Anti-alias chart text smoothens the text graphics.

General->Working Directory this is the directory used to save new tests to. If "Update Working directory to Last file" is checked, then this will update automatically to the folder of the last file selected by the user.

Troubleshooting->Display PCB Temperature this displays the internal temperature of the CBA unit while a test is running

Active Warnings this is a control list of all the toggle-able soft warnings that appear in the software.

CBA Devices

Name	Serial #	Firmware	Calibration Date	License Type	Power	Voltage	MinLoad	Max Current	ADC Speed
CBA #419783	419783			Extended					
CBA #16624	16624	3.00:127	02/15/18 9:42 PM	Extended	150	55	0.150000...	40	1000 ms
CBA #16924	16924			Extended					
CBA #40243	40243	4.09:64F	03/10/21 10:08 AM	Extended	150	55	0.01	40	100 ms
CBA #43532	43532	4.10:64F	09/06/17 1:10 PM		150	55	0.01	40	100 ms

Buttons: License, Delete, Update F/W, Identify, OK

This is a list of the CBA devices known to this software installation. The green check mark indicates units that are currently plugged in to the PC. The units marked **Extended** can use the extended features. To enable extended features, click on a the line marked **CBA** and then click on **License** in the bottom of the window to be prompted for a name and key. Enter the key exactly as provided.

This display can also be brought up by double-clicking on the USB icon in the lower right of the main program window.

 **Unit Test**

This function will run a self test of the CBA unit. It will be best to have a battery or power supply to connect to the CBA for a very short test.

 **Open Config Folder**

This opens the directory of the PC that contains the program preferences and profiles. Use this directory to make or restore a back-up of the CBA settings.

 **Temperature Calibrate**

This is used to calibrate the temperature sensor. Simply connect up the temperature sensor and run this function. Enter the room temperature to calibrate. For highest accuracy, place a lab grade thermometer and the CBA temperature probe placed in water heated to the temperature of interest for testing.

In the standard version of the software, the temperature is displayed and the temperature may be used as a safety feature to automatically stop a test at a user's set maximum battery temperature.

Cable Calibrate

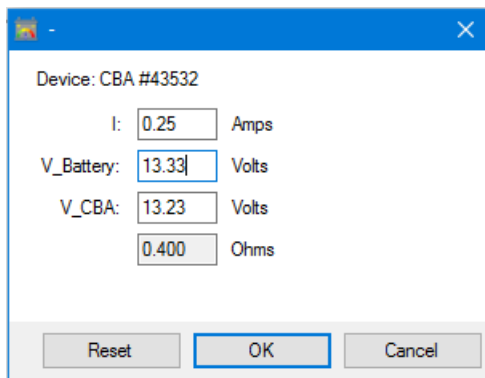

During a high current test there can be a voltage drop between the battery and CBA. This does not affect the current readings. However, it can cause a test to stop earlier than intended. This feature allows for calculating the resistance of the cable and then the software will account for the voltage drop.

Start a high current test running. Measure the voltage at the battery with a DVM. Then invoke this function and enter the battery voltage. Click on OK and the resistance will be used. Complete this again any time a cable is changed.

Web Menu

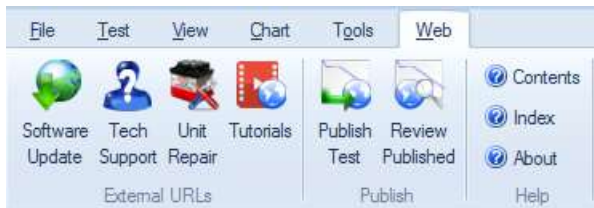

These buttons open a web browser link.

Test Configuration

The new test screen is as follows:

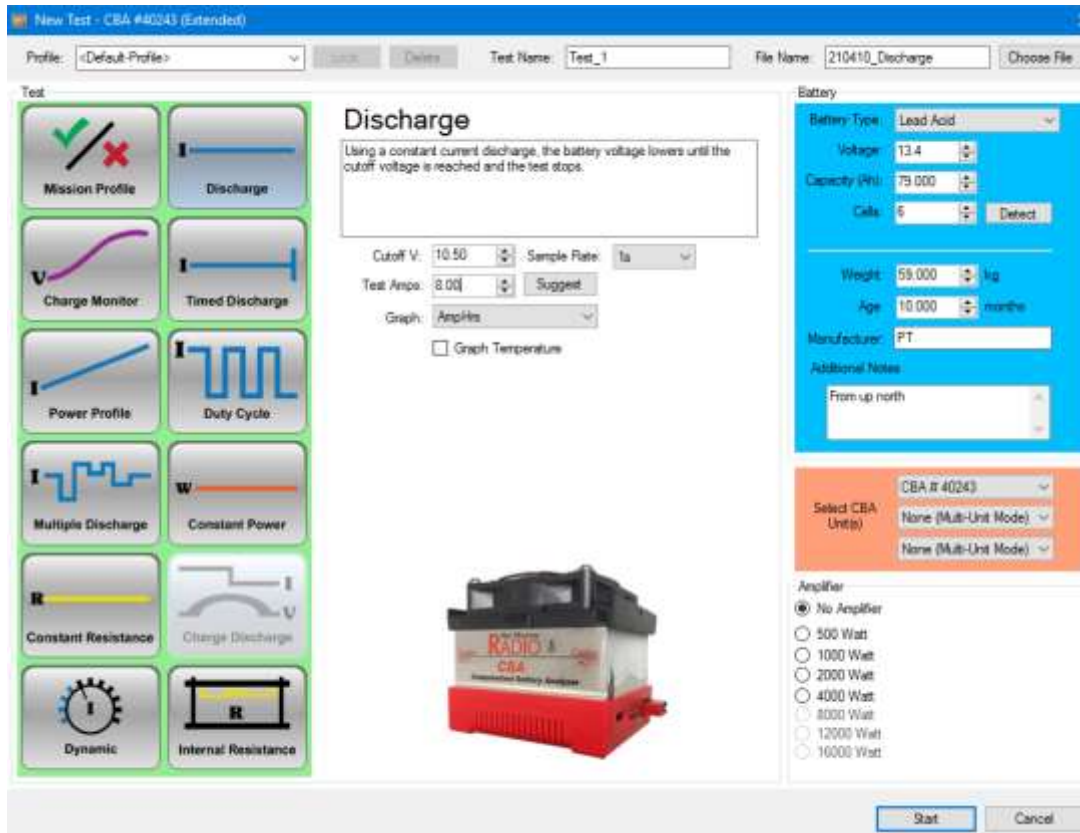

Profiles

Once all the settings have been made in this window, save those settings as a profile in the upper left. The profile can be loaded from this same area. <default-profile> is a special profile that represents the last set of settings created.

Test name is the description for the test entered into the file. Filename is the file this test will be saved in.

Test name is of the format "Test_1" and each appended test simply increments the number: "Test_2", "Test_3", etc.

File name is of the format "yymmdd_TestType_n" where yymmdd is a date code like 210401 for April 1st, 2021 and

TestType is the selected test. n is a number that gets incremented automatically for each new duplicate file.

Battery Description

On the right side in the blue area, various characteristics may be entered that are saved in the test file to help document the test.

NOTE: 100% discharge is never 0 volts for any battery type. There is an industry standard for each chemistry:

Lead-Acid is 1.775 volts per cell

Nickel is 0.9 volts per cell

Lithium is 2.8 volts per cell.

The 100% discharge voltages may vary slightly between different manufacturers and may be dependent on temperature. It is recommended to verify this voltage from the battery manufacturer's specification.

Hardware

In the orange area select the CBA unit that is going to be used. If the CBA units are connected in parallel to increase the current, then enter multiple units. When using an amplifier for even more current, select that here as well.

Test Type

<p>Mission Profile</p>	<p>This is a simplified discharge test. There is an option to run a test until it meets the requirements of the application (Pass) or run until the battery is depleted before the minimum time is reached, the test fails.</p>	<p>Average Current Draw: 0.52 [up/down] Amps [Suggest]</p> <p>Check for Pass/Fail using: <input checked="" type="radio"/> Time <input type="radio"/> Capacity</p> <p>Minimum Duration: 5 [up/down] Minutes</p> <p><input type="checkbox"/> Automatically Stop When Minimum Duration is Reached</p> <p>Graph: AmpHrs [v]</p>
<p>Discharge</p>	<p>Using a constant current discharge, the battery voltage lowers until the cut-off voltage is reached and the test stops.</p>	<p>Cutoff V: 10.50 [up/down] Sample Rate: 1s [v]</p> <p>Test Amps: 8.00 [up/down] [Suggest]</p> <p>Graph: AmpHrs [v]</p> <p><input type="checkbox"/> Graph Temperature</p>

<p>Charge Monitor</p>	<p>Using this test, the CBA will strictly be used to monitor the voltage; the CBA will not draw any load from the battery.</p>	<p>Max Time: <input type="text" value="168.00"/> hours</p> <p>Graph: <input type="text" value="Minutes"/></p> <p><input type="checkbox"/> Graph Temperature</p> <p><input type="checkbox"/> Charge battery using Charge controller</p>												
<p>Time Discharge</p>	<p>This test will discharge the battery until the user specified duration has expired, and then stop the test. This differs from the normal Discharge Test, which would discharge a battery until cut-off voltage has been used.</p>	<p>Cutoff V: <input type="text" value="10.50"/> Sample Rate: <input type="text" value="1s"/></p> <p>Test Amps: <input type="text" value="1.00"/> <input type="button" value="Suggest"/></p> <p>Graph: <input type="text" value="AmpHrs"/></p> <p>Duration: <input type="text" value="1"/> <input type="text" value="Seconds"/></p>												
<p>Power Profile</p>	<p>The test continuously increases the load by the Current Increment while the voltage is graphed versus current or versus power. Using a voltage versus power graph, the peak power output of a battery or power supply can be accurately measured.</p>	<p>Current Increment: <input type="text" value="0.15"/> Amps</p> <p>Initial Current: <input type="text" value="0.000"/> Amps</p> <p>Final Current: <input type="text" value="1.000"/> Amps</p> <p>Hold Time: <input type="text" value="10"/> Seconds</p> <p>Graph: <input type="text" value="Voltage vs. Power"/></p> <p><input type="checkbox"/> Show Voltage Notes (Power vs Current)</p>												
<p>Duty Cycle</p>	<p>The CBA draws a load for a set duration, then stops drawing a load for set duration, and then repeats until the cut-off voltage is reached. The load can be configured to be constant current, constant power or constant resistance.</p>	<p>Cutoff V: <input type="text" value="10.50"/> Sample Rate: <input type="text" value="1s"/></p> <p>Load Type: <input type="text" value="Current"/></p> <p>Current: <input type="text" value="1.00"/> Amps</p> <p>Period On: <input type="text" value="60"/> sec</p> <p>Period Off: <input type="text" value="30"/> sec</p> <p>Graph: <input type="text" value="AmpHrs"/></p> <p><input type="checkbox"/> Stop Test After <input type="text" value="0"/> Cycles</p>												
<p>Multiple Discharge</p>	<p>CBA tests the battery or supply given user defined programming profile. Each step of the profile can be configured for load amount and duration, and the load amount can be configured as constant current or constant power. The profile can also be imported from other analysis tools.</p>	<p>Cutoff V: <input type="text" value="10.50"/> Sample Rate: <input type="text" value="1s"/></p> <p>Steps: <input type="text" value="3"/> Units: <input type="text" value="Amps"/> <input type="checkbox"/> Loop Until Depleted</p> <table border="1" data-bbox="850 1539 1401 1717"> <thead> <tr> <th>Step</th> <th>Amps</th> <th>Duration (s)</th> </tr> </thead> <tbody> <tr> <td>1</td> <td>1</td> <td>30</td> </tr> <tr> <td>2</td> <td>20</td> <td>30</td> </tr> <tr> <td>3</td> <td>0</td> <td>60</td> </tr> </tbody> </table> <p>Graph: <input type="text" value="Minutes"/> <input type="button" value="Import..."/></p>	Step	Amps	Duration (s)	1	1	30	2	20	30	3	0	60
Step	Amps	Duration (s)												
1	1	30												
2	20	30												
3	0	60												

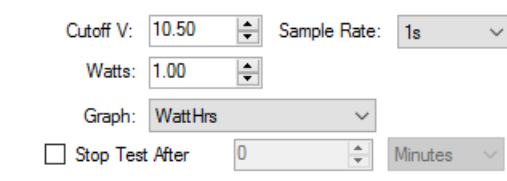
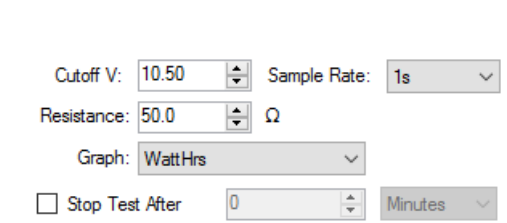
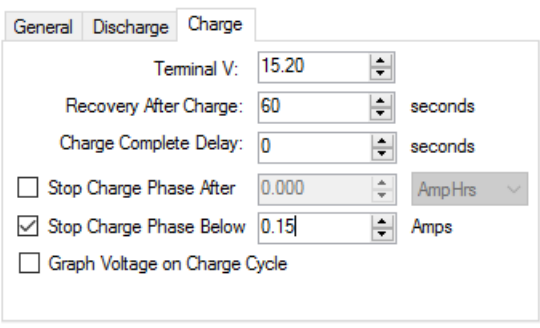
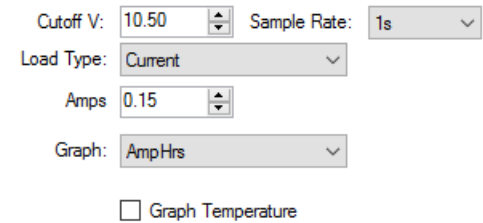
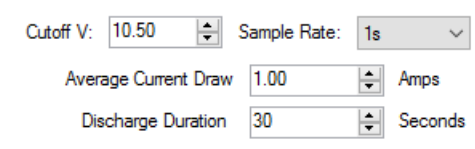
<p>Constant Power</p>	<p>The CBA draws constant power from the supply or battery under test. As the battery voltage decreases during discharge, the load resistance is decreased, thus increasing the load current to maintain constant power per Ohm's law: $P=V*I$</p>	
<p>Constant Resistance</p>	<p>The CBA acts as a constant resistance to draw a load from the supply or battery under test. As the battery voltage decreases during discharge and the load resistance is held constant the load current will decrease per Ohm's law: $R=V/I$</p>	
<p>Charge/Discharge</p>	<p>The CBA discharges the battery, and the CBA Charge Controller activates a charger to recharge the battery. The software can repeat this process for a specified number of cycles. The voltage during the charge/discharge cycle are measured, the capacity during the discharge cycle is measured, and optionally the current of the charge cycle is measured.</p>	
<p>Dynamic</p>	<p>Similar to a discharge test, but the software GUI (graphical user interface) allows the user to change current draw without having to stop and start a new test.</p>	
<p>Internal Resistance</p>	<p>Runs a quick test to measure the internal resistance of the battery. This is done by measuring the terminal voltage and voltage under the specified test load, then calculating</p>	

	the internal resistance by performing a voltage divider calculation with the CBA's resistance.	
--	--	--

WARNING: Never hook the CBA to a battery that has something else connected and that is not totally ground isolated. To test a charge in the charge monitor mode, the charger must be totally electrically isolated from the computer ground.

Significant Features for CBA Type

The following table indicates features that are available to for:

X - for All CBA using Standard Software

1 - Requires Extended Software

2 - Requires a multi-unit license

	CBA I, II, III	CBA IV	CBA HR
Discharge - Apply a current until voltage drops to a specified level	X	X	X
Mission Profile - Run a pass/fail test based on entered data	X	X	X
Power Profile - To sweep a source with varying current	N/A	X	X
Charge monitor to chart voltage during some activity	X	X	X
Charge/Discharge for lifecycle testing (requires hardware)	X	X	X
Duty Cycle testing and multiple discharge level testing	1	1	X
Multiple Discharge - Set a series of current draw levels and time	1	1	1
Constant Power - Adjusts current to maintain fixed watts	1	1	1
Constant Resistance - Adjusts current to mimic a resistor	1	1	1
Timed Discharge - to discharge for a specified time	1	1	1
Dynamic Discharge - For quickly applying a load to the battery	1	1	1
Quick Load Test - Quickly start a Dynamic Discharge test	N/A	X	X
Using Multiple CBA units in the same test	N/A	X	X
Internal Resistance Test - Calculates the battery's resistance	1	1	1
Use multiple units on the same PC in the same program	2	X	X
Use multiple units together to draw higher current discharge	N/A	1	1
Temperature Graphing	1	1	1
User labels on charts	1	1	1
Adjustable sample rates	1	1	1
Calibration for resistance of battery cable	1	1	1
Ragone Charts	1	1	1

Internal Resistance status reading during test	1	1	1
---	----------	----------	----------

Extended Software Features

This section covers the advanced features available only with an Extended License. These features will be grayed out unless a License is purchased and registered. Be sure to enter the name the license should be registered under, CBA serial number and license key in the "Tools > CBA Devices" window.

It is recommended to be familiar with the standard operation of the CBA before learning about and using the Extended features. The "New Test" window will have several additional features.

Note: If running multiple CBA's on one computer, it is an option to have Extended Software running on some, or all of them. Since the software is tied to only one CBA serial number, an individual Extended license must be purchased for each CBA that needs to use extended features.

Once the Extended License is registered, the software will show "(Extended)" on the "New Test" screen along with the CBA name chosen.



New Test Types:

Extended software includes all features included with the standard version and adds several new test types: Timed Discharge, Duty Cycle Test, Constant Power, Multiple Discharge, and Constant Resistance. The CBA HR (high resolution) software package already includes Duty Cycle and Multiple Discharge tests, as standard.

Sample Rate:

The rate at which data is added to the graph can be adjusted. A fast sample rate can be used to spot fast acting events that may have been missed at slower sample rates. A slow sample rate will save less data, resulting in smaller test files. The default sample rate is typically set to 1 second.

Voltage Calibrate:

This calibration feature accounts for resistance in the leads between the battery terminals and the Powerpole® connector on the CBA. Each CBA has its own stored Voltage, Current and Temperature calibration, therefore if using multiple CBA units, it is easy to designate each one with a specific calibration set-up. If the CBA does not seem to be reading correctly, check these

settings first. If an accurate voltage measurement is needed, use the following instructions for the voltage calibration procedure.

NOTE: For maximum accuracy and safety always use very secure, very low resistance connections.

Calibration Procedure:

1. Put a high accuracy voltmeter across the point desired to read calibrated voltage, perhaps across a cell for single cell testing or at the connector supplied with a battery pack.
2. Start a test at the intended current for the battery to test and with the wiring intended to be used for testing.
3. Record the voltage that the software reads "V_CBA:"
4. Record the voltage that the voltmeter reads "V_Battery:" at the calibration point.
5. Record the average "Current" "I:" shown by the software while the voltages are being measured.
6. Stop the test and go to "Tools --> Lab Calibrate --> Voltage Calibrate".

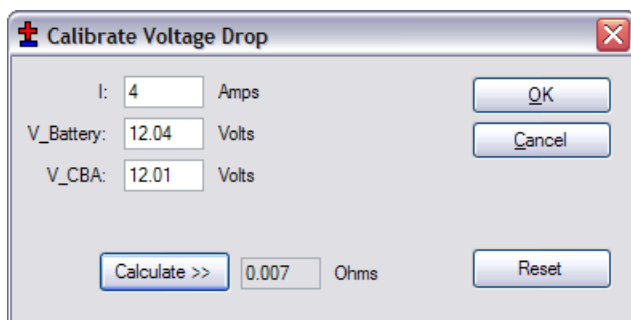

7. In the calibrate voltage window, click "Reset" to clear any previous calibration and then enter readings that have been recorded.
8. Press "Calculate" and the calculated resistance will be valid for all future tests with this CBA and test harness assembly until it is reset. The voltage readings graphed and displayed will be corrected accordingly.
9. Press "OK" to save the calibration settings for future tests with this CBA and harness setup. Note - If the test setup is changed, the recalibration should be performed again, or the custom calibration should be "reset" back to zero factory conditions.

Graph Notes:

Text notes may be added directly onto a graph and associated with a specific graphical line or data point. They may be color keyed and positioned anywhere on the page. Notes are helpful to identify different tests and important observations within an individual test. They are especially useful when complex graphs are overlaid.

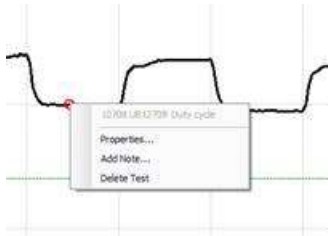

This test below is a graph of a duty cycle test using Voltage versus Time. The test was set for 30 seconds on and 30 seconds off at a 4 amp load.

Move the cursor to the graph until you see the test name displayed. Position the cursor directly onto a specific data point, then right click and select “Add Note”.

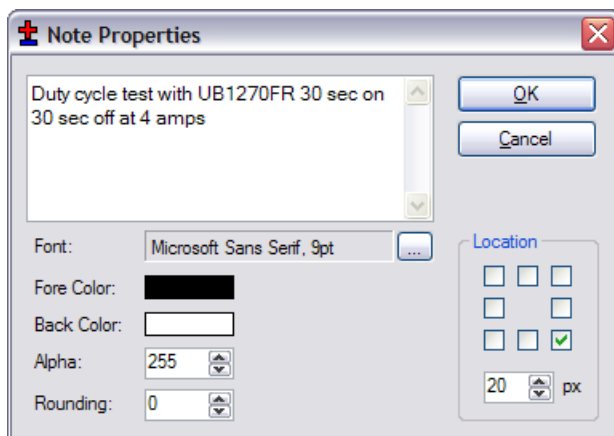

The note properties screen allows for typing the text to be displayed, as well as the location and distance (px) to where the text will be placed, relative to the line data point you selected.

Set the pixels in the “px” box and the direction of offset with the “Location” check boxes.

Font style, color, and size may be edited with selections to the left.



The final note is shown on the graph and may be edited or deleted by right-clicking on the body of the note.

Temperature Graphing:

If using the optional temperature probe and Extended Software, select “Graph Temperature” for most (but not all) test types. This will overlay a second graph on each test screen with the temperature. A temperature probe must be connected to the CBA and calibrated with the sensor in intimate contact with the center of the battery for proper readings.

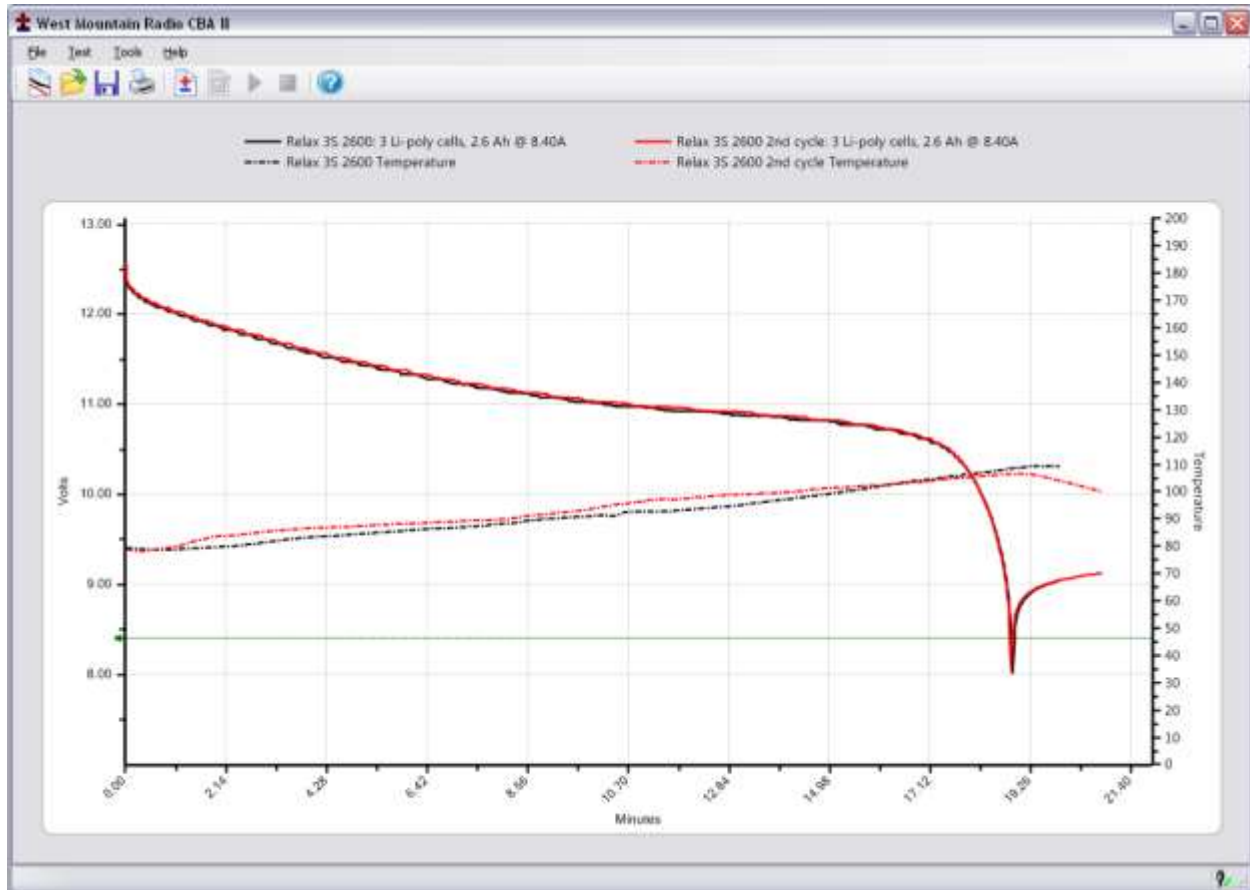

The test will be stopped when the temperature is above the specified threshold or a "Recovery Time" (Discharge Test) can be specified. When the battery reaches the threshold temperature, the test will stop for the given recovery time and then resume. To see the results over time for battery temperature cool down and voltage recovery, use a Voltage versus minutes graph, not Amphrs or Watthrs.

Ragone “Graph” type (Extended Software):

An additional graph type is available with the Extended Software that will compare radically different type and size batteries on the basis of power density (power to weight). This graphing type is particularly useful when selecting a battery to power a device that is weight sensitive, such as small electric vehicles and mobile devices.

- Running other applications not recommended when in use
- Internal USB ports (root hub) required - NOTE: External hubs will not work

It is recommended the computer be dedicated for testing batteries. Do not expect to run other applications while testing batteries. Do not connect or disconnect USB devices while testing batteries. Disable screen saves and sleep modes to prevent loss of computer control during a test.

Multi CBA Operation Only

This section is specific to Multi CBA operation only. Refer to the rest of this help documentation for complete instructions to operate each CBA.

Connection and Installation:

Plug multiple CBAs directly into the USB ports of a desktop computer.

NOTE: If using a laptop computer, all power saving features must be turned off.

If using more CBAs than available USB ports, it is suggested to add an internal USB PCI bus cards that may be purchased at [West Mountain Radio](#).

WARNING: It is not recommended to use or expect an external USB hub to work.

The internal USB PCI bus cards should be installed in the PC like any PCI card. To install the driver files, connect to the Internet so that Windows plug & play system will automatically install the drivers from Windows Update. If the PC does not have access to the internet, use the driver installation files from the CD ROM provided.

Each PCI card has four ports available at the back of the card slot. It does not matter which CBA is plugged into which port on which USB card or PC USB ports, but it is recommended that CBAs are all either plugged directly into the computer, or into the PCI cards; not a combination of both.

Before installing a Multi CBA system, ensure that installation is complete. Run through a stand-alone system test with one CBA. Read the manual and help file completely to be familiar with the operation of using one CBA before trying a multi CBA system.

Go to "Help --> About CBA" and verify having CBA software version 2.1.0.14 or later. If an earlier version is detected, visit the [download page](#) and download and install the latest version update.

Setup

If more than one CBA is connected without a valid Multi-CBA license or CBA IV connected, the program will not start. Licensing and new hardware can be obtained from [West Mountain Radio](#) (No Multi-CBA License is required for CBA IV and/or CBA HR). For further instructions on license entry see Licensing.

NOTE: Do not unplug the USB cables with the program running.

Testing Multiple Batteries:

It is important to carefully identify all tests with multiple CBAs. The software specifically requires a test name for each test. By default it uses that name for the file name when saving the completed test file. However, file name may be changed when saving the test.

One way to keep track of tests is by using a unique number for each battery. If testing the same batteries over and over, consider including the cycle number as part of the test name. Consider including the date or time as part of the name so that it will be visible on a graph when viewed at a later date. This version of the software does allow putting notes on a graph with date and time, or for including that information part of the test name.

To start a new test from a blank screen, click the “New Test document” icon below “File”. This will bring up a small window asking which CBA to use. If unable to distinguish between the different CBAs, select one and click "Identify" - which will blink its green LED. Choose the desired CBA and a “New Test” window will appear along with a tabbed blank graph window behind it. Connect the battery, and select a test profile or correctly fill in the parameters and start the test.

Continue until all of the batteries are being tested or all the CBAs are in use. In a given time, the first test will complete and the corresponding tabbed graph will pop-up over the others. A completed test window will pop-up and the software will “beep” the PC speaker until the test has been saved and discharged battery disconnected

NOTE: Notice the test graph tabs come up in the order the next test was selected. To re-arrange the order, click on the tab with the left mouse button, hold it down, and drag the tab over to a new location.

When a test is completed on a CBA, another battery test may be started while the other CBAs are running. Disconnect the battery and click “Test --> New”. A prompt will appear asking if it should append the graph or start a new one. Only tests of the same type can be appended to the current graph. Connect the next battery and type in the test info and start the test. Do this procedure in order as indicated for best results.

NOTE: When in the process of connecting another battery and starting a new test when a test, it is possible that a different test reaches completion and displays another pop-up completion notice which switches to its completed graph tab. If this happens, simply close the new completed test notice window and finish starting the new test.

Command Line and Script Operation

This section explains how to configure your CBA software to run tests from a command line or scripting language. If using multiple CBAs, first ensure that connecting to multiple CBAs is allowed while the program is operating. If using a CBA IV, this capability is built in. If unsure, start the CBA software and select 'Tools' and then 'CBA Devices'.

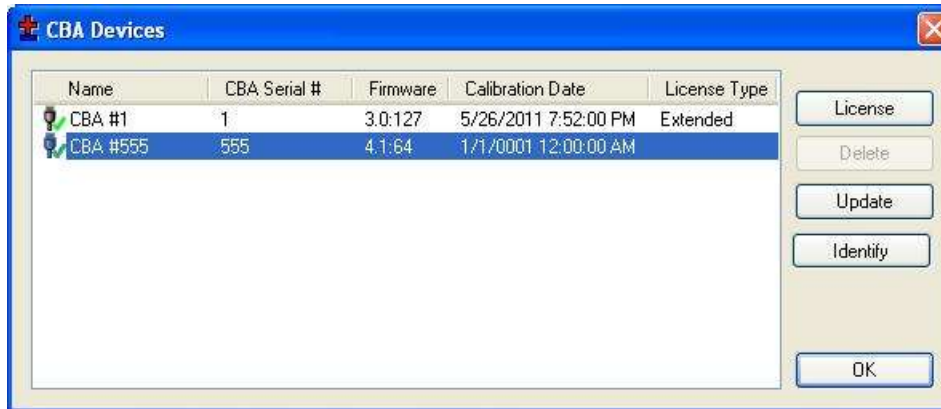

Begin by plugging in the CBAs and if more than one shows up (similar to what is pictured above), please read the help section [Multi CBA](#).

Returning to the scripting language or command line, it is very important that all commands are carefully reviewed before they are run.

NOTE: These command line parameters are for expert users. USE EXTREME CAUTION and please review the [Safety](#) section of this help manual.

CBA Software Command-Line Options:

Items in italics are dynamic, value to be specified by user.

Command	Parameters	Comments
	*discharge <i>amps</i>	Initiate a hands-free test.
	*power <i>watts</i>	A hands-free test will open the software to perform a test, and when the test is complete the software will automatically close.
	*resistance <i>ohms</i>	
	*multiple <i>loop,n,t1,a1,...,tn,an</i>	
/test	*duty <i>amps,ton,toff</i>	The software will return the following result codes when test is complete:
	*profile <i>increment,</i> <i>cutoffcurrent</i>	0 = test run completely -1 = invalid or missing parameters
	*chargedischarge <i>first,cycles,</i> <i>amps,highVoltage</i>	-2 = could not find CBA -3 = parameters are valid, but the power requirements would damage CBA.

Reduce desired test current or reduce test voltage.

-4 = test stopped because internal temperature too high

-5 = test stopped because temperature probe too high

-100 = Critical error, contact West Mountain Radio

-101 = Critical error, contact West Mountain Radio

****This parameter should be given before other parameters:****

The following command-line options are required to use /test:

/cutoff

discharge performs a Discharge Test with constant current draw from the battery.

amps specifies the desired current.

Example (1.5 Amp Test, cutoff at 10.5V):

```
/test discharge 1.5 /cutoff 10.5
```

power performs a Constant Power Test with constant power draw from the battery.

watts specifies the desired power draw.

Example (50 Watt test, cutoff at 10.5V):

```
/test power 50 /cutoff 10.5
```

resistance performs a Constant Resistance Test with constant resistance load on the battery.

ohms specifies the desired load.

Example (5 Ohm test, cutoff at 10.5V):

```
/test resistance 5 /cutoff 10.5
```

multiple performs a Multiple Discharge Test with multiple set points of constant current draw. Loop is optional. If the word loop appears before the other parameters, then the software will loop to the first test point at the completion of the last point. If the word loop does not appear before the other parameters, the software will finish the test when the last test point is complete.

n specifies the number of constant current set points.

tn specifies the duration, in seconds, to draw this current.

an specifies the desired current draw for this set point.

Test will complete prematurely if the cutoff voltage is hit (to stop this affect, set cutoff voltage to 0).

Be aware that CBA Amplifiers draw a small offset current even when 'Disabled'.

When using multiple discharge set points, if there is a set point with 0 load current, there may still be a small offset current if using a CBA Amplifier.

Example no loop (10A for 30 seconds, 30A for 5 seconds, 0A for 20 seconds, 5A for 120 seconds, then test stops):

```
/test multiple 4,30,10,5,30,20,0,120,5 /cutoff 10.5
```

Example with loop (10A for 30 seconds, 30A for 5 seconds, 0A for 20 seconds, 5A for 120 seconds, then loop to first profile point):

```
/test multiple loop,4,30,10,5,30,20,0,120,5 /cutoff 10.5
```

duty performs a Duty Cycle Test at specified *amps* load current, load is applied for *ton* seconds, and not applied for *toff* seconds. *ton* and *toff* cannot be fractional numbers. Test is automatically stopped when voltage drops below cutoff voltage.

profile performs a Power Profile Test with load beginning at zero and increasing every 8 seconds by the specified *increment* until the *cutoff current* value is reached or the battery voltage falls below the */cutoff* parameter.

Example (2A increment with 20 A cutoff current and 8.5V cutoff)

```
/test profile 2,20 /cutoff 8.5
```

charge-discharge performs a Charge Discharge Test that will cycle between charge and discharge cycles until completed. *First* is used to indicate if the test will begin with a charge cycle or discharge cycle. The cycles parameter indicates the number of cycles to complete. A cycle is either a charge or a discharge, so two cycles will result in both a charge cycle and a discharge cycle. The desired load is specified with *amps*. The *highVoltage* parameter provides a limit to the battery voltage during charging.

The following command-line options can also be used with /test:

/battery, /cutoff (Required), /open, /title, /temperature, /graph, /amplifiers, /unit, /chargeunit, /chargegraph, /graphcurrent, /chargeignore, /chargerecover, /chargeamphrlimit

Command	Parameters	Comments
		When performing a hands-free test with /test and saving results to a file with /open, this command sets the battery information. This is only used for informational purposes and does not affect the test parameters. If this is not specified, random data may be saved to the file.
<i>/battery</i>	<i>capacity,</i> <i>cells,</i> <i>voltage,</i> <i>weight,</i> <i>type</i>	Type is battery type, and the following strings are allowed: <ul style="list-style-type: none"> • Alkaline • Carbon-Zinc • Lead Acid (LiFePO4) • Li-ion • Li-poly • NiCd • NiMH • Other <p>Example (4Ah, 6 Cell 13.2V battery, 5.5 pounds):</p> <pre><i>/battery 4,6,13.2,5.5,"Lead Acid"</i></pre>
<i>/cutoff</i>	<i>voltage</i>	Specify the cutoff voltage. If using a hands-free test, this parameter is required, if not specified the program will not run a test. The test is completed when the battery goes below this voltage <p>Example:</p> <pre><i>/test discharge 1.5 /cutoff 10.5</i></pre>

`/open` *filename*

Specify which test results file to open. If a hands-free test mode was initiated with `/test` command-line option, then test results are saved to this file when finished.

Example:

`/open test.bt2`

When using `/test` for hands-free test and saving results to a file specified by `/open`, this option sets the title of this set of data when appending to the file. This parameter is optional. If user does not specify a title, software will use "TEST".

If title is already used in specified file, test name will be appended with an incremental number (ex. "TEST 2" will become "TEST 3").

`/title` *title*

Example:

`/test discharge 1 /open test.bt2 /title "Test XRF200"`

`n` specifies the temperature in Celsius to stop the test, to prevent test from running if external temperature is too high.

`/temperature` *n*

All tests support stopping at the specified temperature (`n`) however, not all tests support temperature graphing. Temperature will be graphed if the selected test supports it and saved to file (`/open`)

`n` specifies the temperature in Fahrenheit to stop the test, to prevent test from running if external temperature is too high.

`/temperatureF` *n*

All tests support stopping at the specified temperature (`n`) however, not all tests support temperature graphing. Temperature will be graphed if the

		selected test supports it and saved to file (/open).
	<i>AmpHrs</i>	
	<i>WattHrs</i>	
<i>/graph</i>	<i>Minutes</i>	If performing a hands-free test (/test), this specifies the graphing format to be used. Ragone graphing only works for discharge tests. Amps and Watts are only available for PowerProfile tests
	<i>Ragone</i>	
	<i>Amps</i>	
	<i>Watts</i>	
<i>/amplifiers</i>	<i>n</i>	For a hands-free test, specifies the number of CBA Amplifiers connected to the system. If this is not specified, it is assumed 0. For multiple CBA operation, this is an optional argument to specify which CBA to use.
<i>/unit</i>	<i>Serial</i>	Example: <i>/unit 40100</i> For multiple Charger Interfaces this is an optional argument to specify which Charger Interface to use
<i>/chargeunit</i>	<i>Serial</i>	Example: <i>/chargeunit 45999</i> For Charge Discharge Test: If specified, will graph Voltage during charge portion of test
<i>/chargegraph</i>		Example: <i>/chargegraph</i> For Charge Discharge Test: If specified, will graph Current during charge portion of test. This will be ignored without "/chargegraph"
<i>/graphcurrent</i>		Example: <i>/chargegraph /graphcurrent</i> For Charge Discharge Test: Delay time
<i>/chargeignore</i>	<i>time</i>	

in seconds to ignore input signals on Charger Interface. DEFAULT: 0 seconds

Example:

`/chargeignore 20`

For Charge Discharge Test: Delay time in seconds between charge and discharge portions of test. DEFAULT: 60 seconds

For Charge Discharge Test: During charging phase this parameter will stop the cycle after the specified number of AmpHrs.

`/chargerecovery` *time*

`/chargeamphrlimit` *AmpHrs*

Example:

`/chargeamphrlimit 2.800`

For Charge Discharge Test: when discharge cycle is complete, this is how long the software will wait before moving onto the charge cycle. The *time* parameter is in seconds.

`/dischargerecovery` *time*

Example:

`/dischargerecovery 20`

For Charge Discharge Test: if this parameter is used, then the software will graph voltage during the charge cycle.

`/graphvoltage`

Example:

`/graphvoltage`

For Charge Discharge Test: if this parameter is used, then the charge cycle will be considered complete if the current going into the battery goes over *Amps* and then below *Amps*.

`/chargeampmin` *Amps*

Example (200MA minimum current:

`/chargeampmin 0.2`

Sets the sample rate, the rate at which data is added to the graph. This requires an extended software license.

The time parameter is in milliseconds.

Not all time values are valid, use the software in non-handsfree mode to verify valid values for your hardware.

`/samplerate` *time*

Example (250ms sample rate:

`/samplerate 250`

Hands Free Testing

An external software program, or script, can initiate a hands-free test by executing the software with the `/test` command-line options.

For example:

```
"C:\Program Files\CBA IIIWMRCBA2.exe" /test discharge 2 /cutoff 10.5 /open
result.bt2
```

The software will remain open and run the test until the test has completed. For most tests, it is completed when battery voltage has dropped below cutoff voltage. For multiple-discharge test, test will complete after the specified duration has expired -or- the cutoff voltage is reached, which ever happens first.

When the test is complete, the software will close and return an error code to the external software program or script.

A batch file is present in the executable directory that shows a working of example of calling the .EXE and handling the returning error level.

CBA HR Auxiliary Connector

The CBA HR contains a 3.5 mm auxiliary connector jack, positioned just to the left of the large Powerpole test connectors. There are two remote circuit functions associated with this connector, thus the connector jack serves two purposes.

It can be used with optional 4-wire measurement harness, which provides enhanced battery test voltage sensing by moving the CBA HR's voltage sensing function from the large Powerpole (current) connectors, to an isolated measurement circuit (via 3.5 mm plug) to minimize test-lead resistance voltage drop.

A second circuit within the 3.5 mm plug serves as the remote input for optional magnetic temperature probe (requires Extended Software license).

Note - Since the CBA HR automatically switches its battery test voltage measurement from Powerpole to 3.5 mm connector whenever a 3.5 mm plug is inserted into the auxiliary input, the use of an optional temperature probe **ALSO** requires the use of remote voltage sensing wire lead harness.

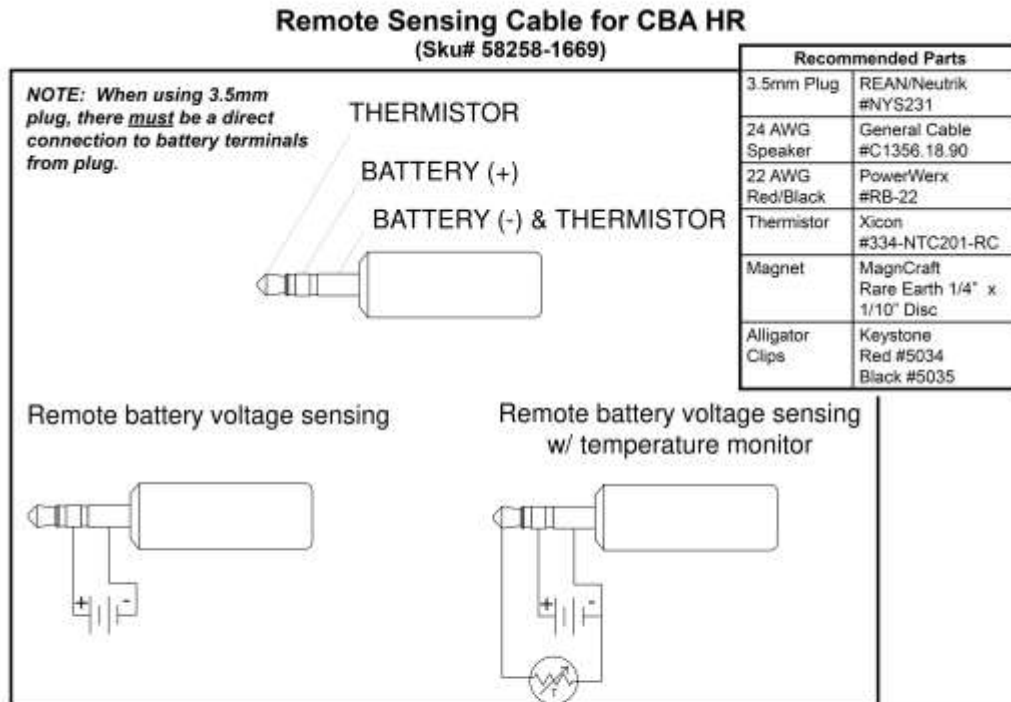

Serial Port

Interconnection

The CBA has a 5 pin accessory port where PIN1 closest to the LEDs.

The CBA HR does not have a serial port. Sections covering RS-232 signal pin-outs and AT Command programming language do not apply to CBA HR.

In order to use this accessory port with a serial interface, disconnect the USB and power the CBA through the accessory port. 5V power should be able to source at least 200 mA. The serial interface is 3.3V TTL and 5V tolerant. The Baud Rate is 2400.

PIN1	GND
PIN2	Reserved
PIN3	POWER
PIN4	Tx
PIN5	Rx

NOTE – CBA pins 1 & 2 are used for optional Temperature Probe input. Review that section for additional details on temperature sensor connections.

The following is a schematic to convert computers RS-232 signal to communicate with the CBA.

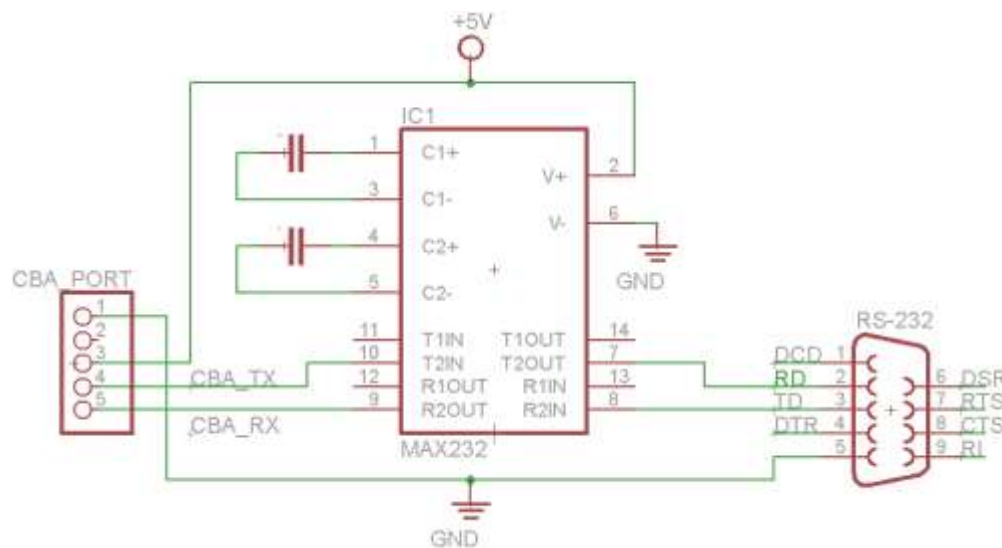

Commands

WARNING: It is very important that all commands are carefully reviewed before they are run. This interface is for expert users. USE EXTREME CAUTION and please review the [Safety](#) section of this help manual.

Use the following AT commands to interface your application with the CBA.

Function	Command	Parameters	Description
Read	AT*VER	<i>Version</i>	Firmware version AT*VER?
Write	AT*TEST	<i>TEST_UA,</i> <i>TEST_UV,</i> <i>TEST_UA,</i> <i>TEST_UV</i>	Specify in microAmps and microVolts. Values are entered twice to ensure proper settings and error detection.
		<i>or</i>	Stop current test AT*TEST=0

			Load=1.25 Amps, VoltageCutoff=4.5 Volts AT*TEST=1250000,4500000,1250000,4500000
		0	Returns the status of the current or completed test. Voltage in microvolts and Current in microamps. PLIM is 1 when test is Power Limited
Read	AT*STATUS	SECONDS, READ_UV, TEMP, TEST_UA, TEST_UV, PLIM, STOP_REASON, CS	STOP_REASON [1]Running, [2]Low Voltage, [3]Over Temperature, [4]Other (likely user stop) TEST_UA, TEST_UV and SECONDS will retain their previous value until a new test starts. AT*STATUS? Response to AT*STATUS? or Automatically sent by the CBA every <i>interval</i> seconds specified in AT*SEND CS - Check Sum - sum all digits and add number of digits (not commas) then modulus 256
Notify	*STATUS	SECONDS, READ_UV, TEMP, TEST_UA, TEST_UV, PLIM, STOP_REASON, CS	*STATUS=95,5056604,9999,0,0,0,1,94 To calculate Check Sum: Sum digits = 77 + 17 digits = 94 % 256 = 94
Notify	*STOP	STOP_REASON, SECONDS, 0	STOP_REASON listed as text. "OTHER","VOLTAGE","TEMP" SECONDS at Test Stop
Write	AT*SEND	INTERVAL	INTERVAL in 100's of ms, at which the *STATUS message is automatically sent. AT*SEND=50 Status update every 5.0 seconds. AT*SEND=0 No status updates
Read	AT*SEND	INTERVAL	INTERVAL in 100's of ms, at which the *STATUS message is automatically sent. AT*SEND?
Write	ATE0	none	Echo Off (default)
Write	ATE1	none	Echo on

Example Program

```
(hidden) ATE1 //Turn echo on to see as you type

AT*SEND=50 //Set status updates for every 5 seconds

AT*SEND? //Get Current Interval

AT*SEND=50 //Confirmed status update interval

//Set test for Load=1.25 Amps, Voltage Cutoff=4.5 Volts

//Values in microvolts and microamps

AT*TEST=1250000,4500000,1250000,4500000

*STATUS=5,11462368,9999,1250000,4500000,0,1,118

*STATUS=10,11463655,9999,1250000,4500000,0,1,116

//A while later

*STATUS=1200,4529254,9999,1250000,4500000,0,1,122

*STOP=VOLTAGE, 1201, 0

//Test Stopped Because of low voltage at 20:01 minutes (1201) seconds

//Status Messages Continue
```

*STATUS=1200,4496851,9999,1250000,4500000,0,2,133

*STATUS=1200,4487823,9999,1250000,4500000,0,2,132

AT*SEND=0 //Turn off Status updates

AT*STATUS? //Get Status Manually

AT*STATUS=1200,4491300,9999,1250000,4500000,0,2,117

Accessories

CBA Charger Interface

Charge / Discharge Test

The West Mountain Radio Charge Controller has the following inputs and outputs:

- **IN-A and IN-B:** These should connect to a signal on the charging unit that indicates charging is complete. An LED will suffice. These inputs can handle up to 12V.
- **OUT-A and OUT-B:** These outputs are shorted (relays closed) when the software is starting a charge cycle. The purpose of this is to connect to a push-button on a charging unit, where the push-button might control the start/stop of the charger.
- **Powerpole[®] Connectors:** When a Charge/Discharge test is not running, or during the Discharge cycle of a Charge/Discharge test, these Powerpoles[®] will be open. During a Charge cycle, these Powerpoles[®] will close (short) and the West Mountain Radio Charge controller and the CBA Software can read the current drawn by the battery from the charger unit.
- **Green LED:** LED is lit when the CBA software has connected to the West Mountain Radio Charging Interface board.
NOTE: There is a green power LED also.
- **Yellow LED:** LED is lit when the CBA software is currently performing a Charge/Discharge test. The Yellow LED will turn off when test is complete.
- **Red LED:** LED is lit when the CBA software is currently in a charging phase of a Charge/Discharge test (the Powerpoles[®] are closed and the charging unit is connected to the battery).

When starting a charging cycle, the CBA software will close both the **OUT-A** and **OUT-B** relays and leave them closed for the duration of the cycle. If this is not compatible with the charging unit or more flexible options are needed, contact West Mountain Radio to assist in supporting a particular charging unit.

While performing a charging cycle, the CBA software will look for a signal high on either **IN-A** or **IN-B** to signify a charge complete. If this is not compatible with the charging unit or more flexible options are needed, contact West Mountain Radio to assist in supporting a particular charging unit.

Typical Setup

The CBA and battery are both connected in parallel to the indicated Powerpole[®] connector. When the test is in Discharge, the relay on the Charge Controller is open and creates an open circuit. Similarly, during charge mode, the CBA acts as an open circuit while the Charge Controller relay is closed and the battery is charged. The following is a setup diagram:

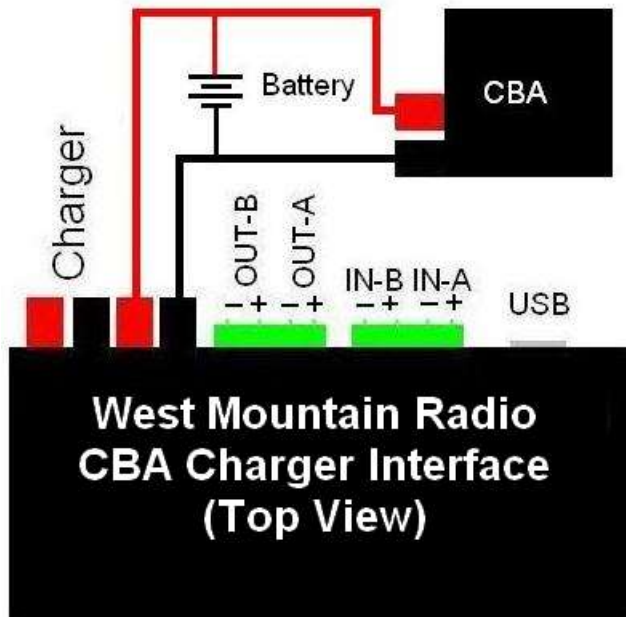

Temperature Probe

Temperature Graphing (Extended Software Version)

If an Extended License and the Temperature Probe accessory have been purchased, the option of graphing an external temperature and stop a test if an external temperature hits a user-specified threshold is available. Simply click the 'Graph Temperature' radio button when setting up a Discharge Test. If running a standard Discharge Test, there is also "Recovery Time" check box and time box. Recovery time allows a load test which has been completed to continue for additional time to record any overshoot in the battery's temperature rise. It will also allow a running test which has paused due to over temperature (as set in Tools > Preferences) to continue after cooling.

CBA IV - Plug the temperature probe two-pin flat connector into the right most pins (closest to the LEDs) of the available pins in the cover slot. It does NOT make any difference which way it goes in as long as it is plugged in to the far right two pins. The extra pins are for future options.

NOTE: If using this software with a CBA II, do not remove the blue jumper. CBA III and CBA IV do not have this jumper.

For CBA HR, the optional temperature probe is connected via a 3.5 mm accessory jack located near the Powerpole connectors. Be advised - when a 3.5 mm plug is inserted, you MUST also

implement 4-wire remote voltage sensing. This is required since the 3.5 mm input serves two purposes - temperature and remote voltage input. When the plug is inserted, the CBA HR's internal voltage sensing (normally connected internally to the Powerpole connectors) is disconnected and routed out via the 3.5 mm plug. Thus using a temperature probe ALSO requires use of a remote 4-wire type battery load sensing connection harness. See [CBA HR Auxiliary Inputs](#)

Calibration - Allow the probe sit in a location away from any heat source for enough time to acclimate to room temperature. Have a good thermometer nearby, to determine an accurate temperature reading. For laboratory quality measurements, consider calibrating near the temperature of interest by submersing both the probe a high accuracy thermometer in the water warmed to near the temperature expected during your test.

With a temperature probe connected to the CBA, go to "Tools", "Lab Calibrate", "Calibrate Temperature Probe" and enter the accurate reference temperature reading in either degrees C, or F, the reference temperature reading and click OK to save that calibration. This will serve to "teach" the CBA software to associate the exact temperature with the resistance reading of the thermistor in the probe.

Note: Temperature Probe should not need to be recalibrated as long as the same CBA unit is being used.

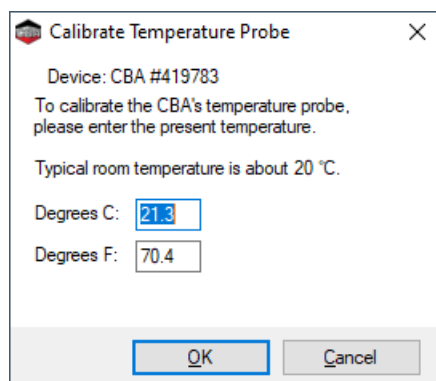

To use the probe, attach it in close physical contact with the center of the battery, or battery pack being tested. Hold it in place with the probe's magnet (most round cells are magnetic), or with tape or a rubber band (for better contact and more accurate readings thermal compound may be used). Be certain it stays in close contact with the battery during the test. The CBA temperature readings are quite accurate over the range that a battery may be operated, however readings will be incorrect if the probe is not in close contact with the battery or there is air moving over it. Unlike an instant response IR thermometer, other types of thermometers take a considerable amount of time to display their temperature reading. There is a noticeable thermal lag with our thermistor type probe.

The CBA may be set for automatic over temperature cutoff. Place the probe on the battery. Go to “Tools”, “Preferences” and check the check box next to “Stop test when battery reaches ? deg”. Fill in a temperature appropriate for the battery (60 degrees C or less should be safe for most batteries).

WARNING: DO NOT continue a test if the "Temp:" indication reaches or exceeds the maximum temperature specification for the battery being tested.

Support

If you cannot find the answer to a question about using the CBA here in this manual and help files, you may get help several other ways.

Web Support: <http://www.westmountainradio.com/support>

Email: support@westmountainradio.com

Phone: 262-522-6503 x32

Fax: 262-522-6504

Mail: West Mountain Radio
1020 Spring City Drive
Waukesha, WI 53186

For problems with the computer or USB port, contact the computer manufacturer.

For problems with the Windows operating system, contact the computer manufacturer if Windows came pre-installed or Microsoft directly.

For problems with a battery or a product being used with it, contact that manufacturer or supplier.

Licensing

To purchase an Extended license follow the instructions on [West Mountain Radio](#). License information will be sent by email. *NOTE: This information is case sensitive.*

After receiving the information start the program and connect the CBA that matches the License information. Click on the connected icon at the bottom right, or go to “Tools > CBA Devices”.

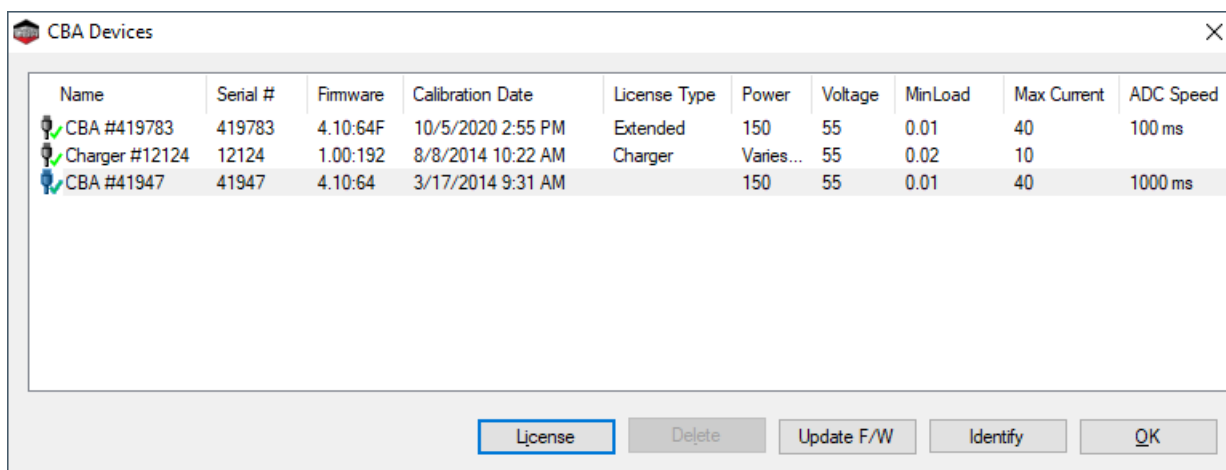
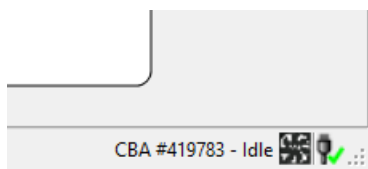

Select the connected CBA that the license is valid for and click “License.”

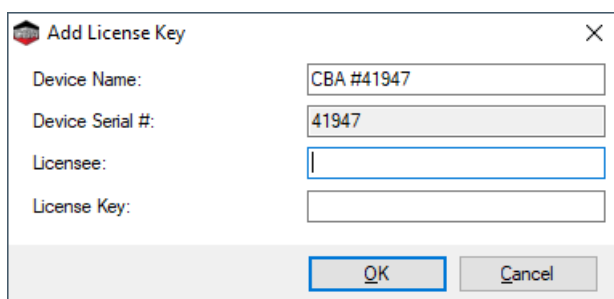

Enter your registration information exactly as shown in the email “Licensee:”, “CBA serial #:” and the “License Key:”. Optionally enter a “CBA Name:”, which is suggested if planning to use multiple CBAs in the future.

Clicking "Identify" will flash the selected CBA's green LED for a few seconds - which is useful when running a large group of CBAs on one computer. The default name contains the serial number preceded by "CBA #". It is good practice to choose a unique name to identify this particular CBA to distinguish from others that may be in a larger group running on one computer.

If prompted to do so, close the program after registering the license and then restart the CBA software.

Firmware Updates

Some CBA devices have the capability to be updated with new firmware.

Update Procedure:

1. Open the list of CBA devices by selecting 'Tools' and then 'CBA Devices' from the menu.
2. Select the CBA you wish to update, and if this CBA device has the capability to be updated the 'Update' button will be available.
3. Clicking 'Update' will prompt the 'Update CBA Firmware' window. This window provides the selection to choose which firmware to update using the pull-down labeled 'File'. Pressing the 'Update' button will cause the firmware to be sent to the CBA.

The 'Device' and 'Status' section of the window will show a status during the update process. After new firmware is sent to the device, the 'Status' section will say 'Success' when the CBA is ready to be used again.

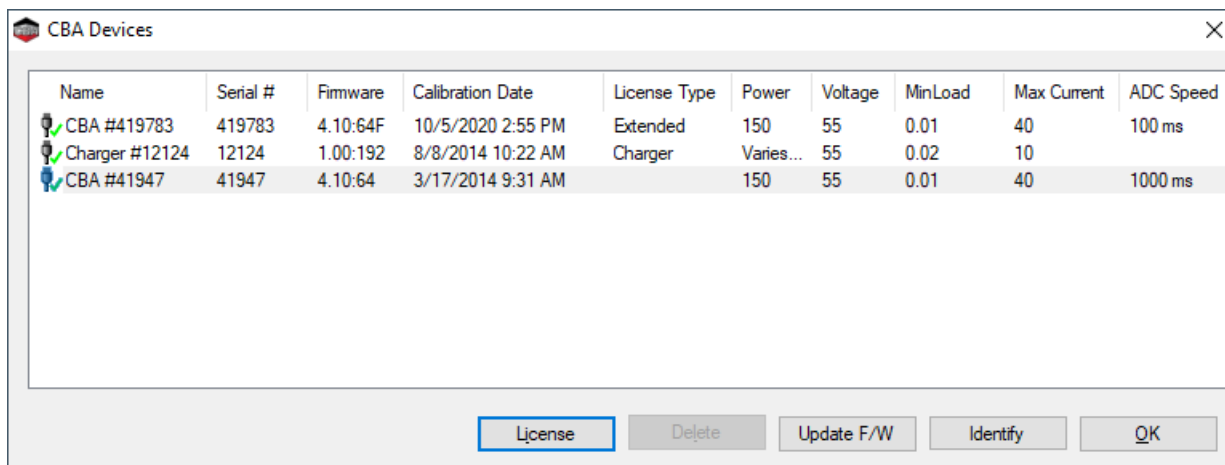

Name	Serial #	Firmware	Calibration Date	License Type	Power	Voltage	MinLoad	Max Current	ADC Speed
CBA #419783	419783	4.10:64F	10/5/2020 2:55 PM	Extended	150	55	0.01	40	100 ms
Charger #12124	12124	1.00:192	8/8/2014 10:22 AM	Charger	Varies...	55	0.02	10	
CBA #41947	41947	4.10:64	3/17/2014 9:31 AM		150	55	0.01	40	1000 ms

Buttons: License, Delete, Update F/W, Identify, OK

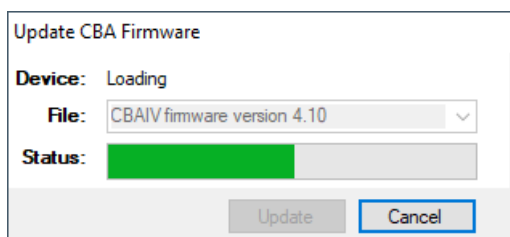

Update CBA Firmware

Device: Loading

File: CBAIV firmware version 4.10

Status:

Buttons: Update, Cancel

WARNING: DO NOT unplug the CBA IV during a firmware update.

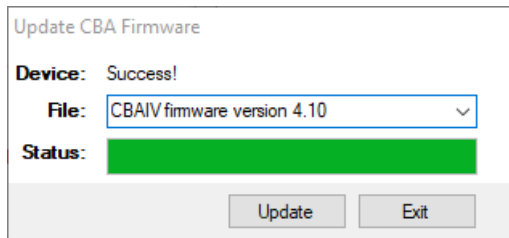

The CBA update is complete.

Troubleshooting

No CBA units available

If the CBA program indicates “No CBA units available” when opening a new test window; and/or the CBA green LED or virtual LEDs are not on when a CBA is connected and the program is running - the Windows® CBA USB driver installation may not have been properly completed.

Re-boot the computer. Plug the CBA back in. Repeat our hardware installation instructions and try it again.

If it still does not work, open Device Manager:

- In Windows 7, this can be done by opening Control Panel, selecting 'System and Maintenance', selecting 'System' and then selecting 'Device Manager'.
- In Windows 10, this can be done by opening Control Panel, selecting “System”, selecting Device Manager.
- From the device manager, scroll down to “Universal Serial Bus Controllers” and expand + that list. If the CBA is not located, try looking in the section labeled 'Other Devices'. When the CBA is located, right click on it and select 'Remove Device'. Then disconnect and reconnect the CBA back into the PC. If the CBA software persists on not recognizing the CBA hardware, contact West Mountain Radio support.

CBA Charger Interface is not connecting

Make sure the CBA is software running and try reconnecting the USB cable to the Charge Controller.

CBA does not indicate voltage

The battery may not be connected or it is completely dead.

OR

CBA unit may be damaged. Contact West Mountain Radio support.

OR

CBA HR may have a 3.5 mm plug inserted into its auxiliary port, thus disconnecting internal voltage sensing from the Powerpole battery test connectors.

CBA gets too hot and shuts itself off

The CBA has an internal temperature monitor that is programmed to protect it from overheating when operated at maximum ratings and at normal room temperature.

Make sure the fan is running during a test, nothing is blocking the cooling inlet, and the CBA is being operated in a relatively cool location. Do not use it in direct sunlight or on near a heat source, such as too near the battery being tested.

Do not attempt to conduct successive high current tests without letting the CBA cool down and shut off its fan between tests.

Some CBA Menu selections are grayed out and do not work

These are typically the optional features available only with the Extended Software License. Visit www.westmountainradio.com to purchase an Extended License.

No load drawn from CBA during test, or test runs but battery voltage never decreases

The usual cause for this is the internal safety fuse in the CBA has blown. If this is suspected, remove the red lid from the bottom of the CBA and check the automotive style ATOATC fuse connected to the PCB (25A for CBA; 2A for CBA HR). Verify this fuse is okay and replace if necessary. If running high power CBA IV tests, it might be necessary to replace the factory installed 25A fuse with the 40A fuse, as separately, packed with each new CBA IV. If the fuse is okay but the CBA is still not drawing power, contact West Mountain Radio support.

Computer System Requirements

Basic Requirements:

- A PC with a Pentium 233 or better
- At least an 800 X 600 graphics card and display monitor
- Windows 98SE, ME, NT, 2000, XP, Vista, Windows 7 (32 or 64 bit), Windows 8, Windows 10
- An available USB port

Recommended:

- AMD or Pentium, 1.2 GHz better.
- Better than 800 X 600 graphics card and display monitor.
- Windows XP, Vista or Windows 7, Windows 8, Windows 10
- 1 GB or more RAM
- An available USB port

For graph and label printing:

- Any Windows compatible, laser or ink jet, color or black and white, printer
- Avery 5160 (laser) or Avery 8160 (Inkjet) labels are required for label printing